

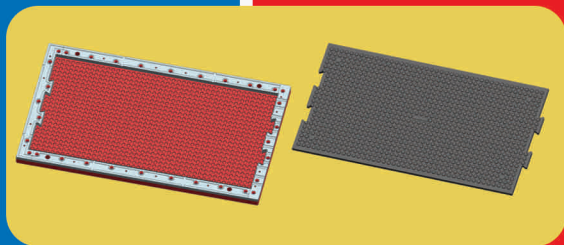

- 📍 Major Industrial Estate
Ollur, Thrissur, Kerala - 680306
- ☎ 0487 2355979, 7736498137
9847132410, 9847451556
- ✉ pentadies@gmail.com
- 🌐 www.pentadies.in

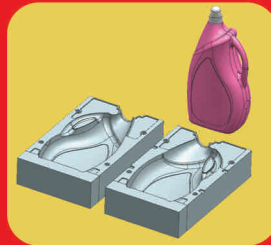

Mfrs:- Plastic Injection Moulds , PVC Fittings Moulds , Hot Runner Moulds
Thin Wall Container Moulds, Extrusion Blow Moulds, Stretch Blow Moulds (PET)
Master Mould for Rubber Industry.

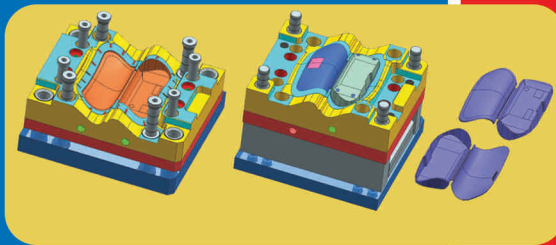
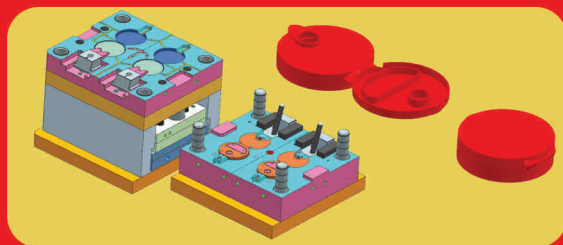
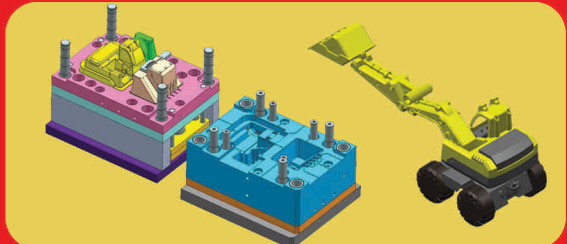
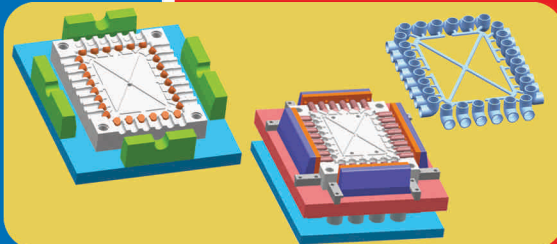
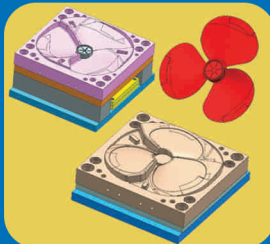
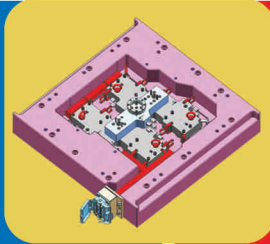
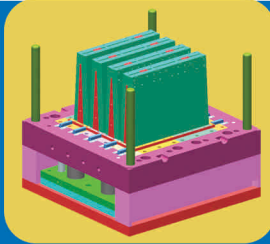
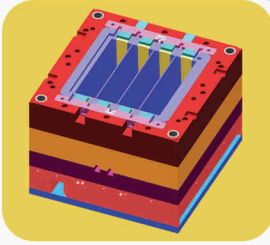
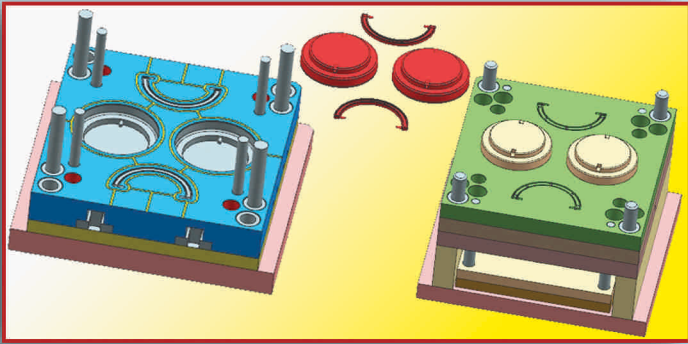

Handle Cap Mould

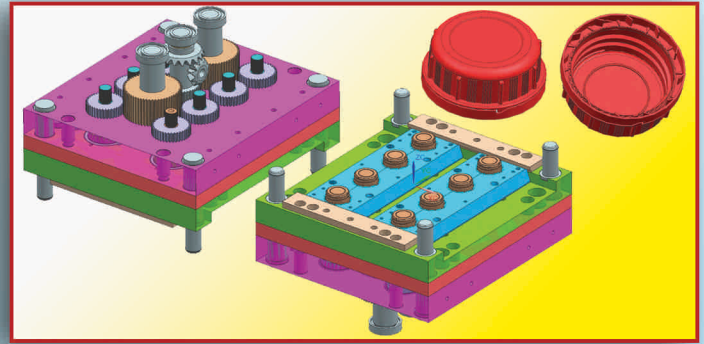

Break Cap Gear Mould

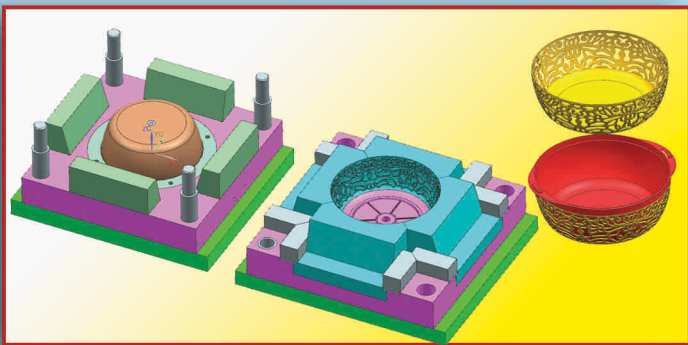

Double Moulded Bowl Mould

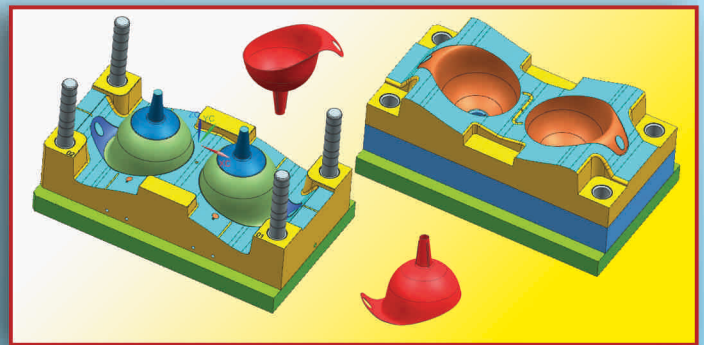

Funnel Mould

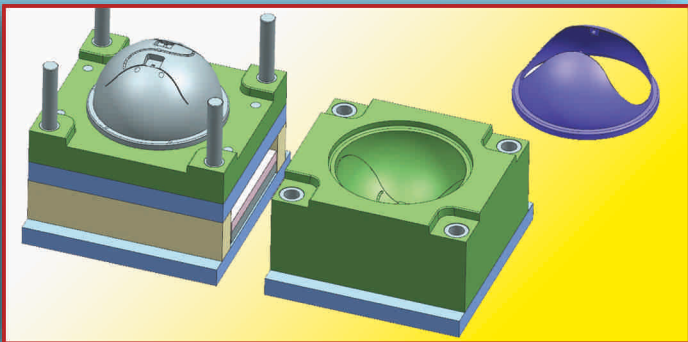

Waste Bin Cover Mould

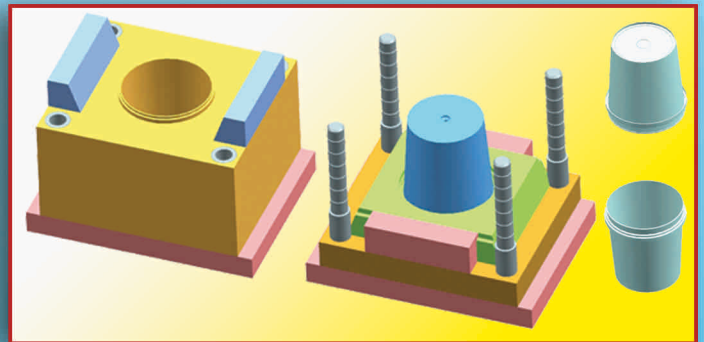

Paint Bucket & Container Mould

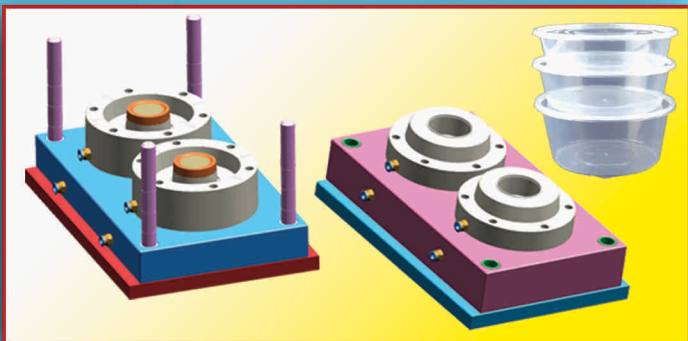

Thin Wall Container Mould

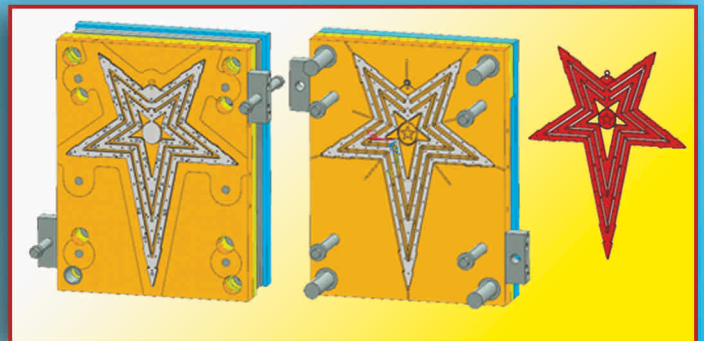

Xmas Star Mould

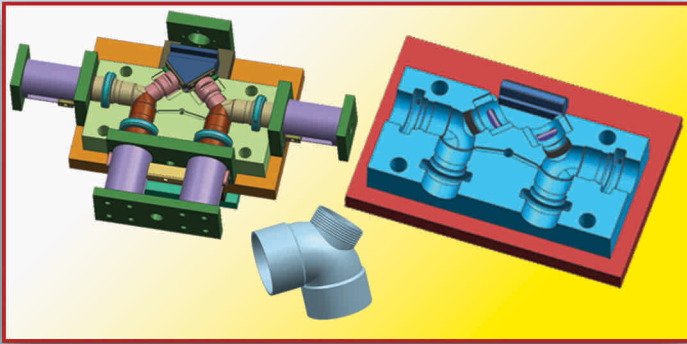

PVC Door Elbow Mould

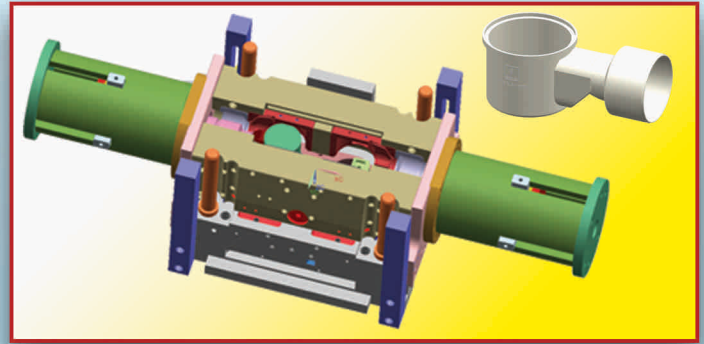

PVC Nahani Trap Mould

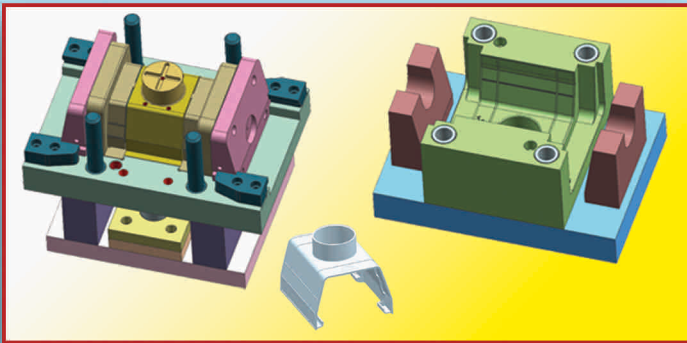

Rain Water Gutter Fitting Mould

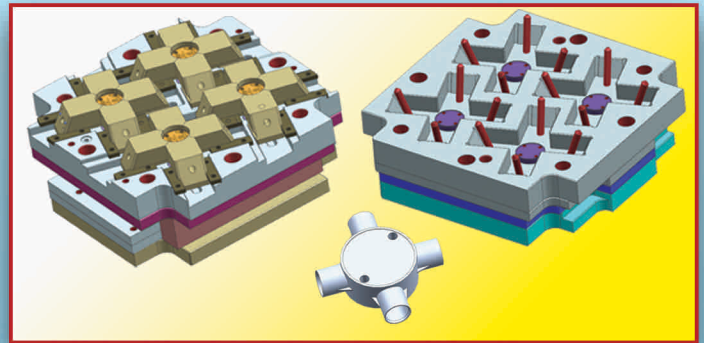

Junction Box Mould



Extrusion Blow Mould



Stretch Blow Mould (PET)

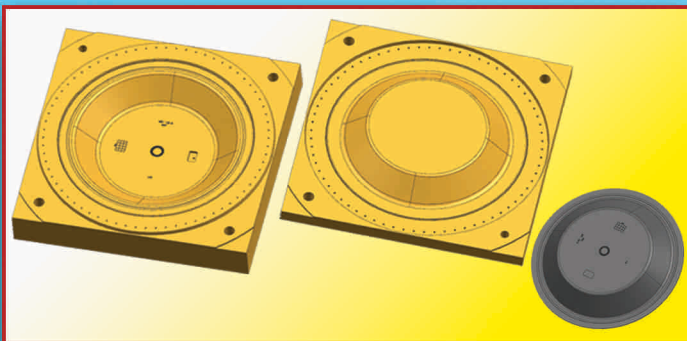

Rubber Diaphragm Mould

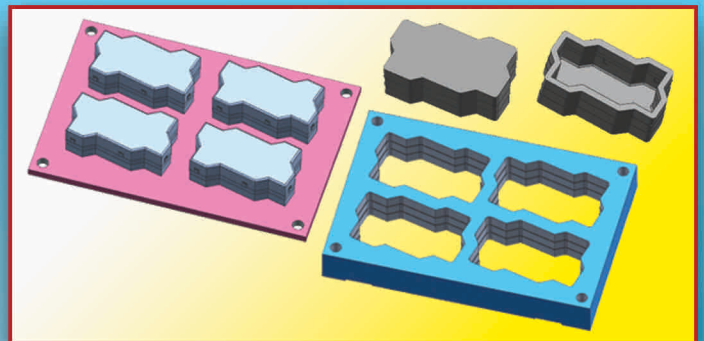

Master Die for Rubber Mould

ABOUT US



Penta dies is an ISO 9001-2015 company which were started in 1994, and it has emerged as one of the leading manufacturing Company of all types of Plastic Injection Moulds, PVC Fittings Moulds, Hot Runner Moulds, Thin Wall Container Moulds, Extrusion Blow Moulds, Stretch Blow Moulds (PET), Master Moulds for Rubber Industries, CNC Milling Job Works and all type of new products mould design.

Penta has always bringing superior quality products with innovations to cater the constantly evolving global scenario in terms of application and requirements. Penta have 5 nos of well equipped factories in Kerala and Karnataka with most modern CNC milling machineries like HAAS, BFW, STM & JYOTI. We have around 150 nos of well experienced employees with hundreds of satisfied customers all over India and Abroad.

We achieved this by God's grace with continues research and hard work. Our motto is to deliver best quality product and service for our beloved customers in cost effective and time based manner. Penta group is very much interested to discuss with your esteemed organization for sharing our knowledge and experience.



Major Clients

Neethi Tcr 8921812104



Our Sister Concern

